

gez. / drawn  
gepr. / appr.  
Titel / title:

01.03.2015  
01.03.2015

Andreas Kandler





Maße / Dimensions: mm  
Original: DIN A3  
Blatt / sheet 1 von / of 1

Consolidation Point 19" 1HE

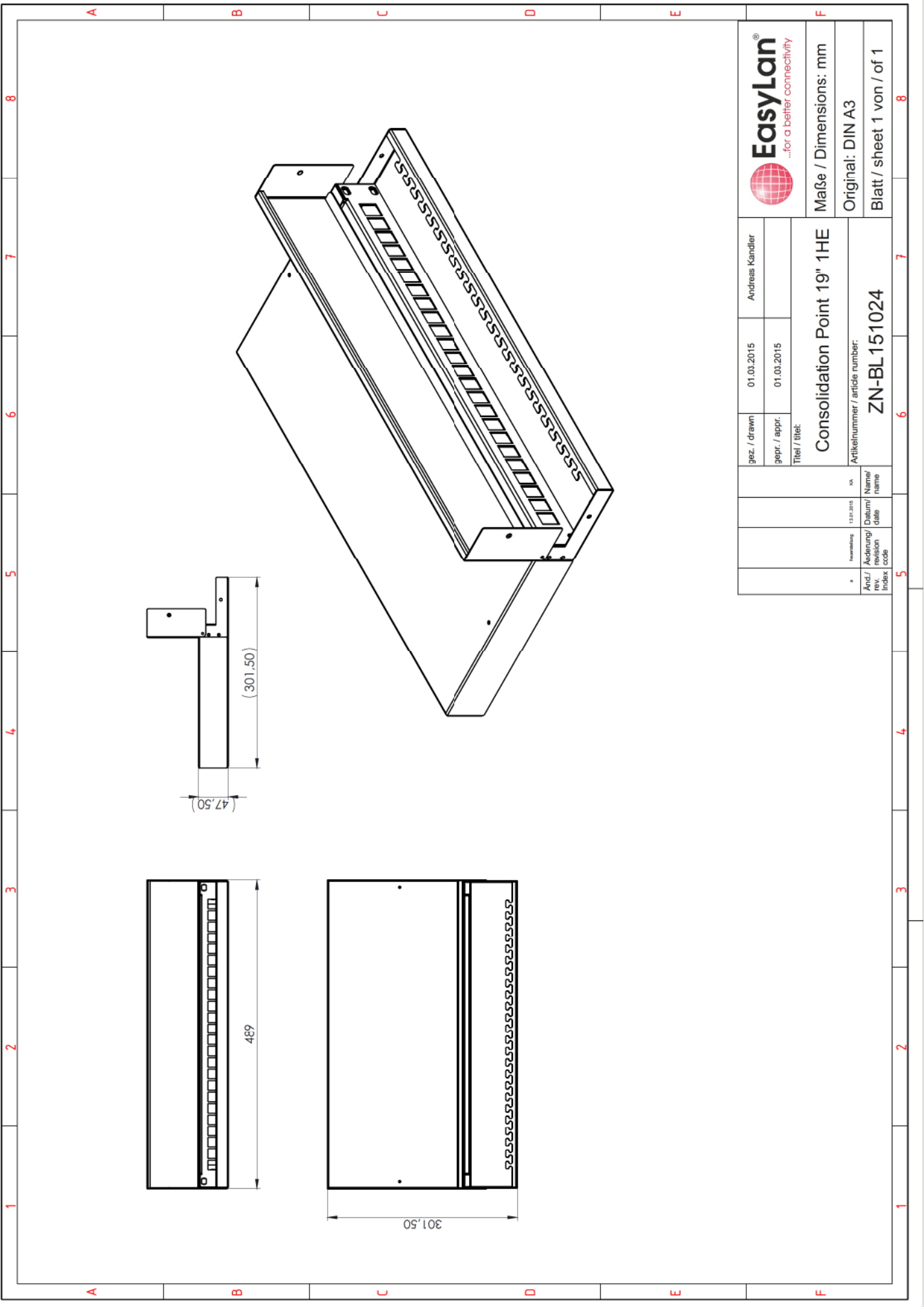
Artikelnummer / article number:  
ZN-BL151024

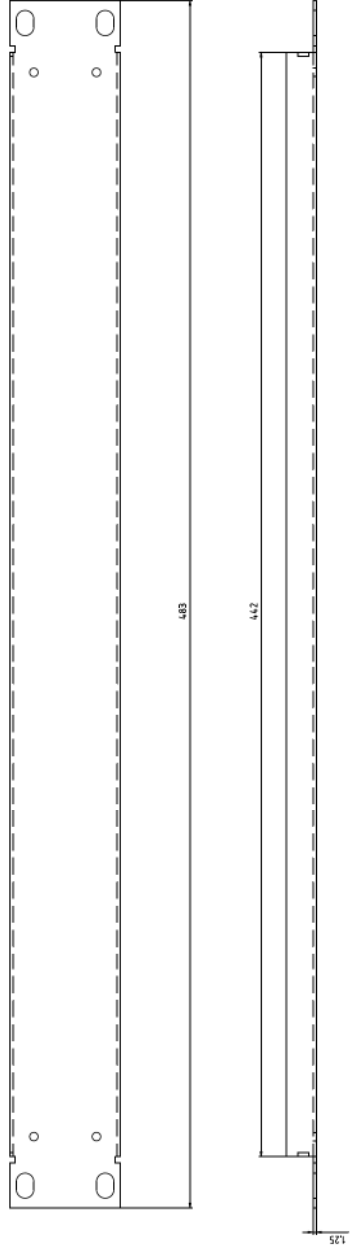
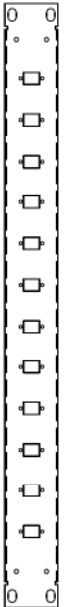
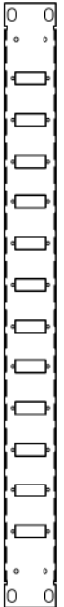
Änd./ rev. Index	Änderung/ revision	Datum/ date	Name/ name
		13.07.2015	USA

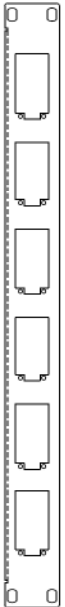

1	2	3	4	5	6	7	8
A	B	C	D	E	F		
							
		<p>12x SC-S/LC-D/LSH</p>	<p>12x SC-D/LC-QUAD</p>	<p>12x SC-D/LC-QUAD HORIZONTAL</p>	<p>12x LSH-COMPACT</p>	<p>24x RJ45 KEYSTONE</p>	<p>24x SC-S/LC-D/LSH</p>
							<p>24x SC-D/LC-QUAD</p>
							<p>24x ST/FC</p>
							<p>24x LSH-COMPACT</p>
							<p>24x PRELINK EXTENDER</p>
							