

483

43,7

445

240

Spezifikationen:

Gehäuse Stahlblech verzinkt, Seitenteile Pulverbeschichtet



Maße / Dimensions: mm
Original: DIN A4
Blatt / sheet 1 von / of 6

gez. / drawn	25.07.2016	Jungbeck
gepr. / appr.	25.07.2016	Fuchs
Titel / title:		
Baugruppenträger BGT 19" 1HE		
Artikelnummer / article number: ZN-BL161039_A		
a	Neuerstellung	25.07.16
Änd./ index	Änderung/ revision	Datum/ date
		Name/ name

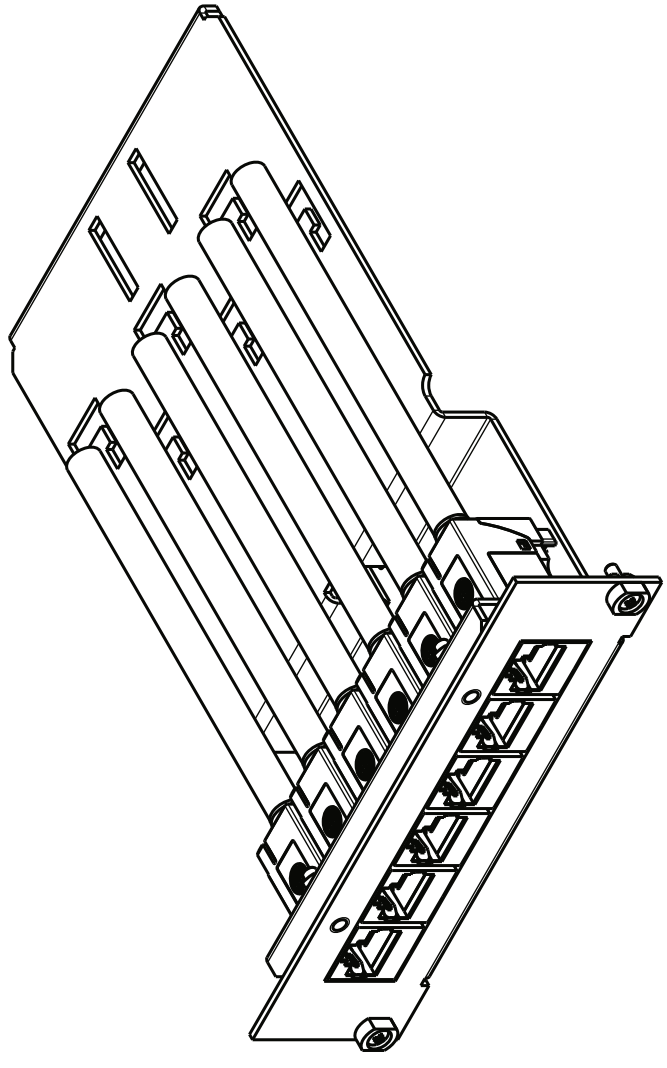
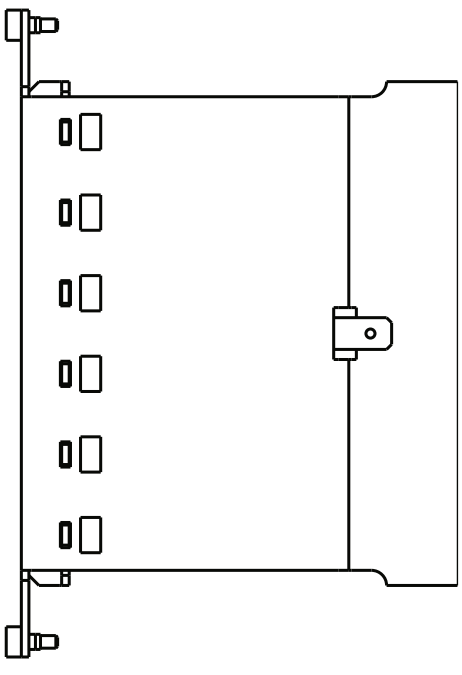
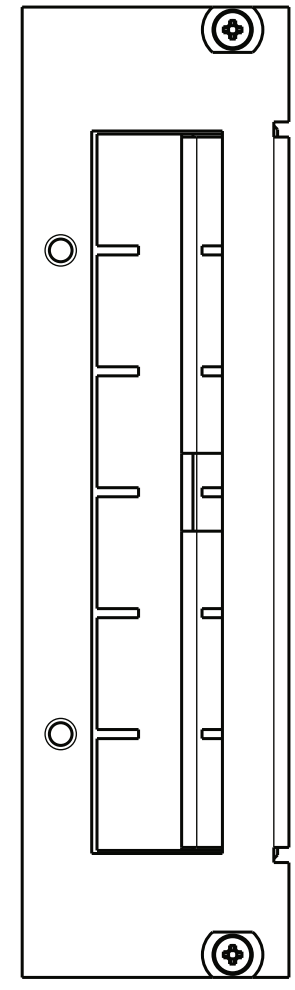

Aufnahmewinkel 6x Keystone-Modul

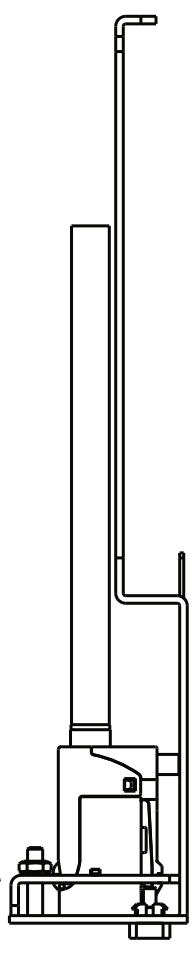

Maße / Dimensions: mm
Original: DIN A4
Blatt / sheet 2 von / of 6

gez. / drawn	29.06.2015	Kandler
gepr. / appr.	01.07.2015	Fuchs
Titel / title: BGT Einschubmodul preLink® / fixLink® 3HE 7TE für 6x KS		
a	Neuerstellung / Änderung / rev. / revision Index / code	29.06.15 Datum / date
Artikelnummer / article number: ZN-BL151041_A		Kandler Name / name

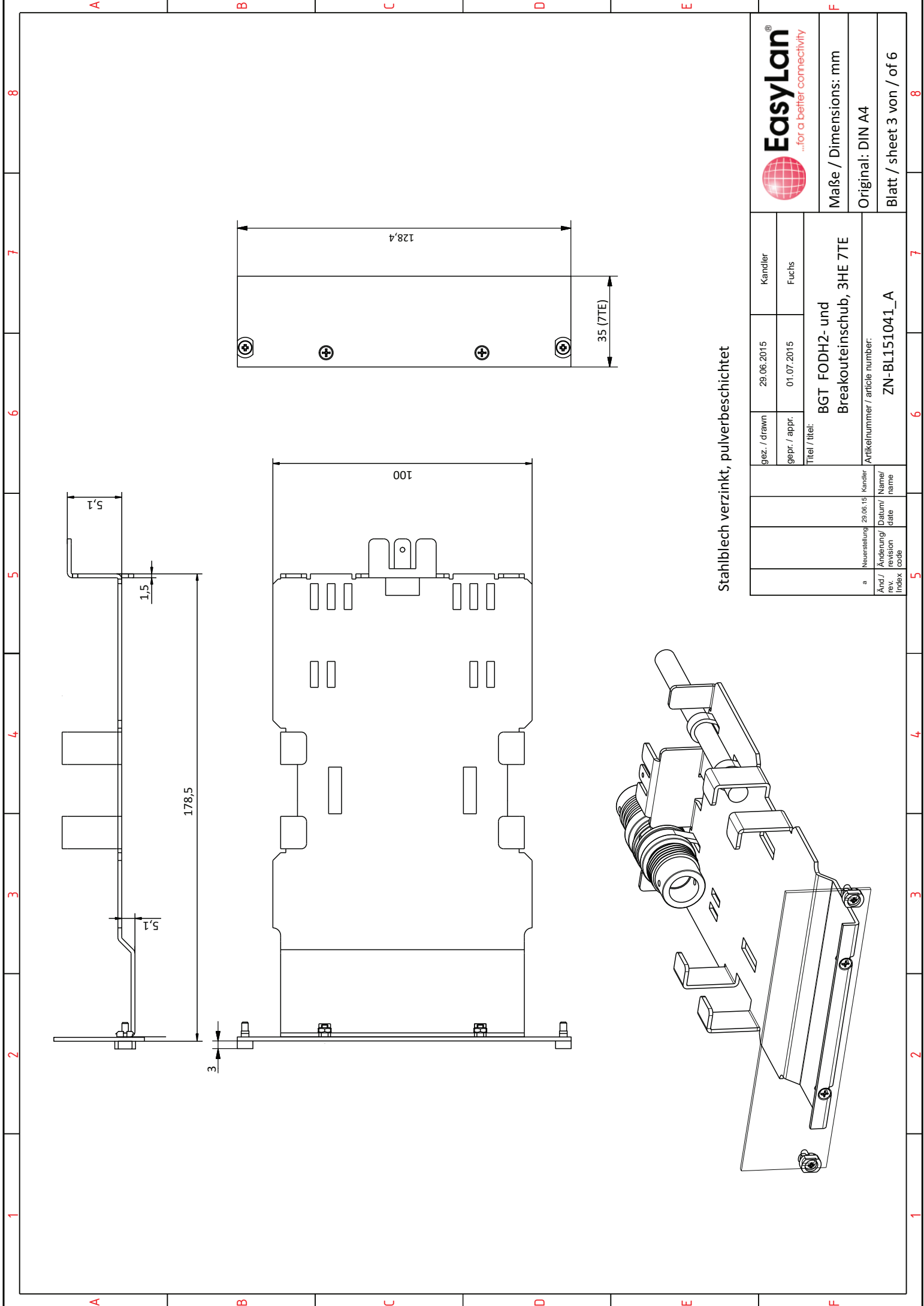

Stahlblech verzinkt, pulverbeschichtet

Easylan®
...for a better connectivity

Maße / Dimensions: mm
Original: DIN A4
Blatt / sheet 3 von / of 6

gez. / drawn	29.06.2015	Kändler
gepr. / appr.	01.07.2015	Fuchs
Titel / title: BGT FODH2- und Breakouteinschub, 3HE 7TE		
Artikelnummer / article number: ZN-BL151041_A		
a	Neuerstellung	29.06.15
Änd./revision/index	Datum/date	Name/name

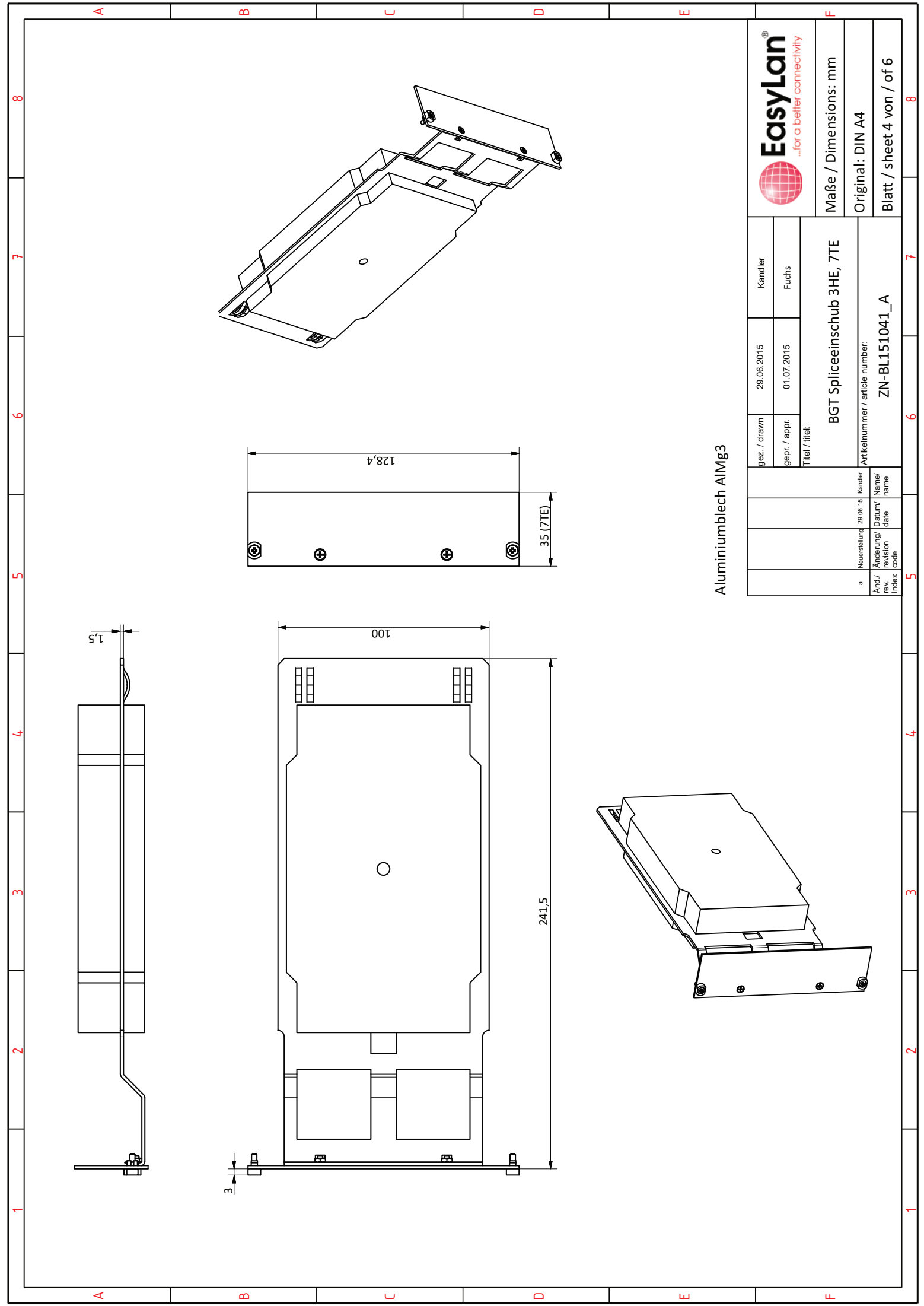

Aluminiumblech AIMg3

gez. / drawn		29.06.2015	Kändler	
gepr. / appr.		01.07.2015	Fuchs	
Titel / title:				
BGT Spliceinschub 3HE, 7TE				
Artikelnummer / article number:				
ZN-BL151041_A				
Neuerstellung		29.06.15	Kändler	
Änderung / revision			Name / name	
Index			date	
			code	
Maße / Dimensions: mm				
Original: DIN A4				
Blatt / sheet 4 von / of 6				



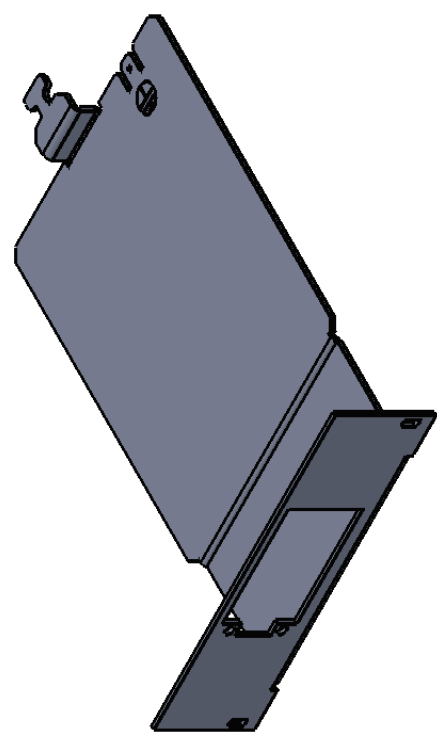
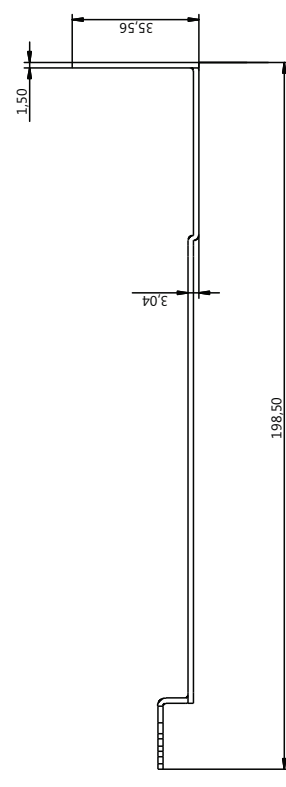
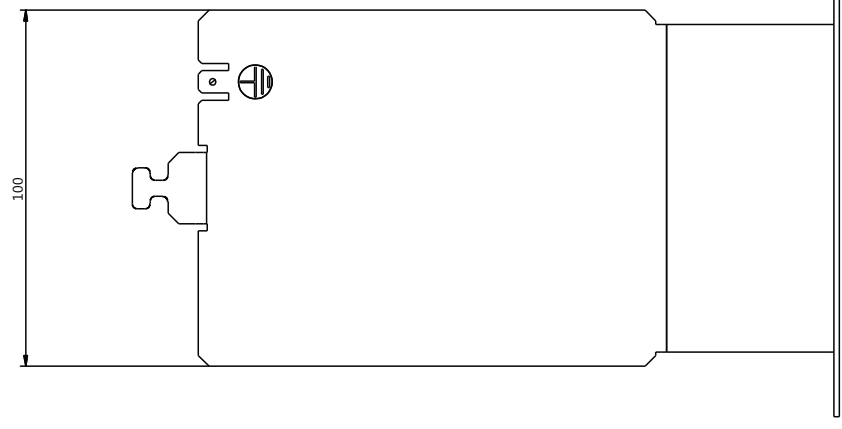
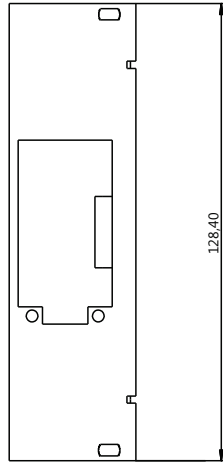

Stahlblech verzinkt, pulverbeschichtet



Maße / Dimensions: mm
Original: DIN A4
Blatt / sheet 5 von / of 6

gez. / drawn	29.06.2015	Kändler
gepr. / appr.	01.07.2015	Fuchs
Titel / title:		
BGT Einschub - 1x H.D.S. 3HE, 7TE		
Artikelnummer / article number: ZN-BL151041_A		
a	Neuerstellung	29.06.15
Änd./ revision index	Datum/ date	Name/ name

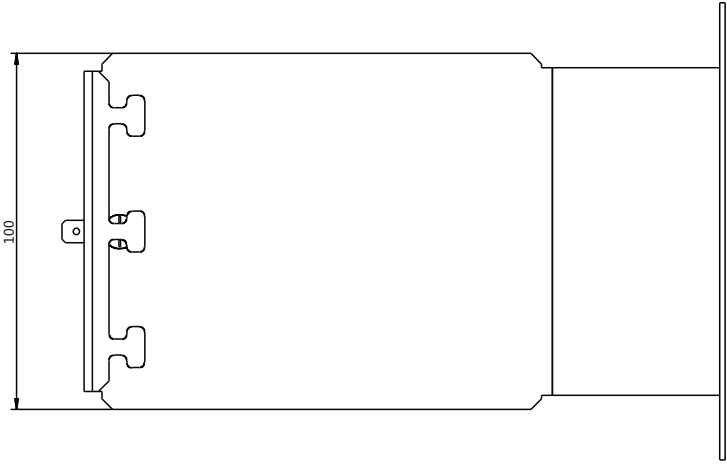
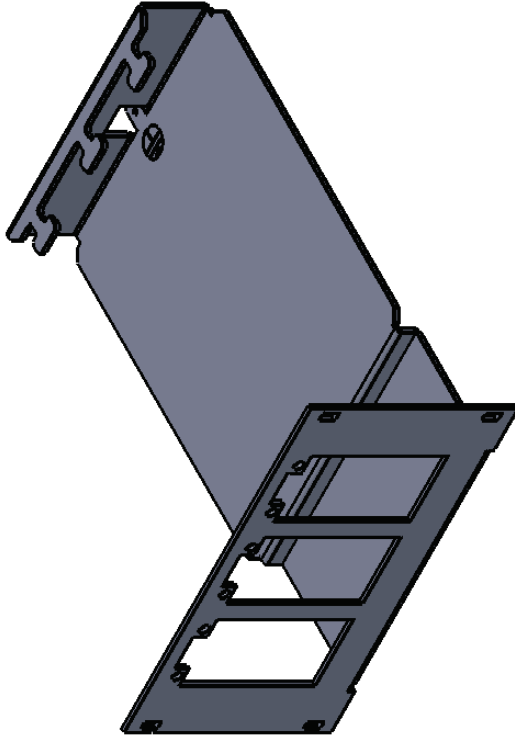
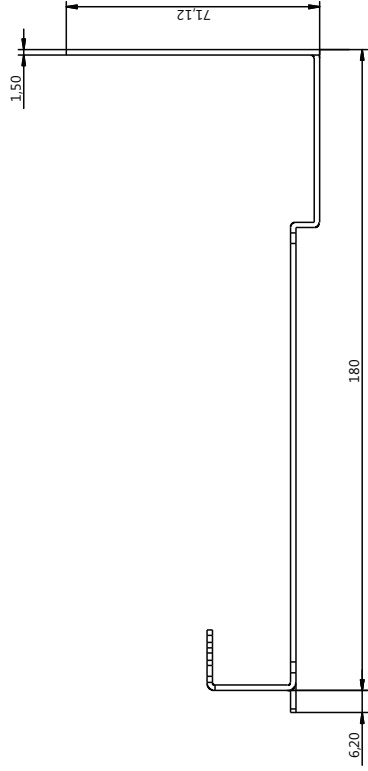
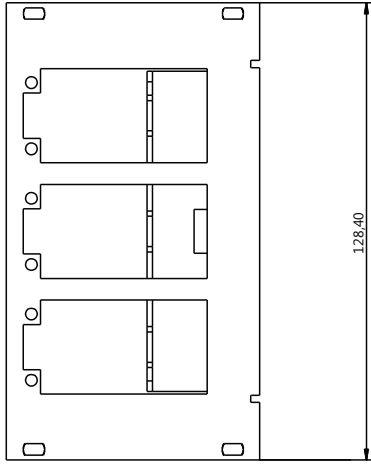

Stahlblech verzinkt, pulverbeschichtet



Maße / Dimensions: mm

Original: DIN A4

Blatt / sheet 6 von / of 6

gez. / drawn	29.06.2015	Kändler
gepr. / appr.	01.07.2015	Fuchs
Titel / title:		
BGT Einschub - 3x H.D.S. 3HE, 14TE		
Artikelnummer / article number: ZN-BL151041_A		
a	Neuerstellung 29.06.15	Kändler
Änd./ revision index	Datum/ date	Name/ name